

SYNERGY Flex

Automatic Sliding Door

Control the door from your smartphone



Elegance & Intelligence combined with strength and performance.

Perfect solution for new construction or integration into existing structures. Suitable for public places with heavy traffic flow such as retail, health care, leisure, etc.

Features and benefits

- Powerful motor.
- Battery backup in case of power failure.
- Logic box for managing integration of all features including keypads, alarm systems, etc.
- Control interfaces that offer high performance with user-friendly Bluetooth technology.
- Four heavy duty Delrin rollers per moving panel for smooth & quiet movement.
- Carriage cleaning system to minimize dust and debris.
- Glass stops for easy glazing & glass replacement.
- Full vertical height interlock on (FBO*) with double weather strip seal for optimizing energy conservation.
- Full breakout capability for maximum egress.
- Aesthetically pleasing contoured profile.
- Modular assembly allows for easy installation and minimizes wiring time.
- Breakout panel catches at the top of SX panels keep them aligned and guide panels back into place after "breakout".
- Fixed Sidelite (FSL*) and surface mount options available.

* FBO - Full Break Out - FSL - Fixed Sidelite



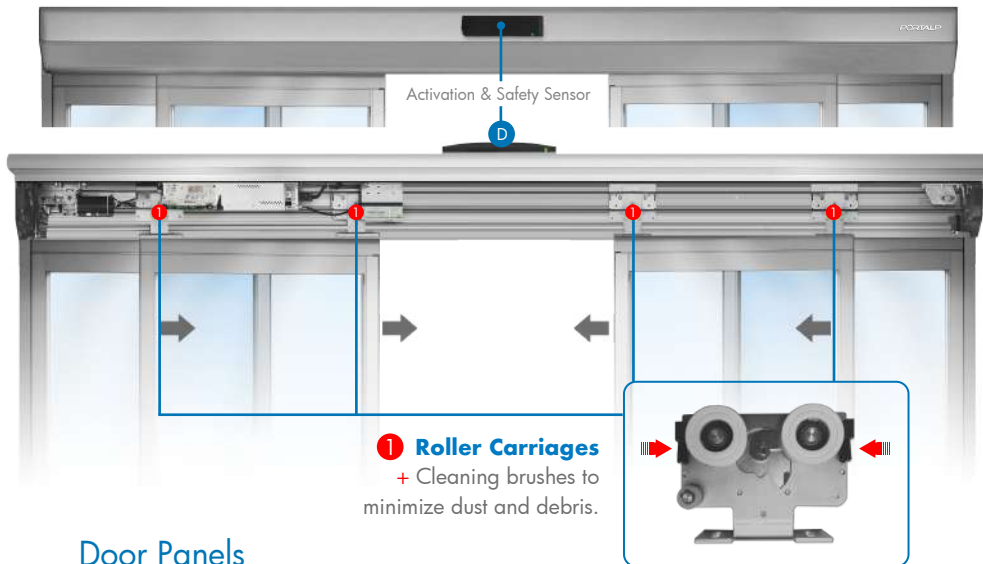

1 Roller Carriages
+ Cleaning brushes to minimize dust and debris.

Access Controls

A Control the door from your smartphone

- Clean display in your language
- Intuitive navigation
- Direct modes selection
- Easy user settings
- Bluetooth, Low Energy
- **Autodoor Master** for installation set up and troubleshooting (with Android only).



Creation of virtual keys for each user
Up to 32 users per door
4 user-configured functions
Faults reporting

Autodoor Pilot
For the end user to change the status of the door.
Automatic opening control
Locking / unlocking
Priority opening

Door Panels

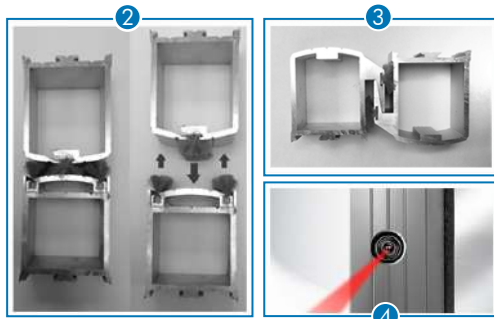

- 2** Total weather seal when doors are closed to form a real air infiltration barrier.
- 3** Full vertical height interlock with double weather strip seal.
- 4** Safety beam sensors available.

B Naviblu, a wall mounted door control using one central browsing button for door status changes (**Optional**)



C 6-position key selector / 3.2" & 1.6" (**Optional**)



Detection Devices

D Hyperfrequency detection and active Infrared safety.



Hyper frequency radars ensure reliable performance and movement detection. The monitored infrared safeties detect any presence in the passageway or any obstacle hindering the panel closure.

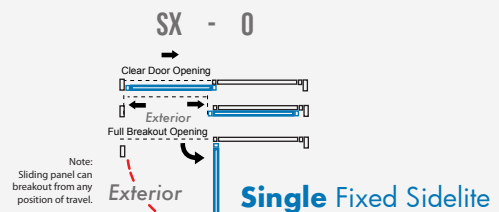
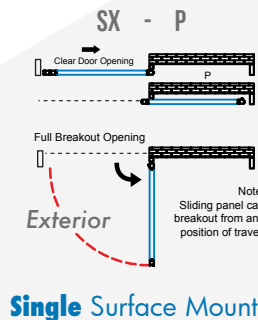
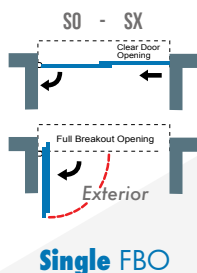
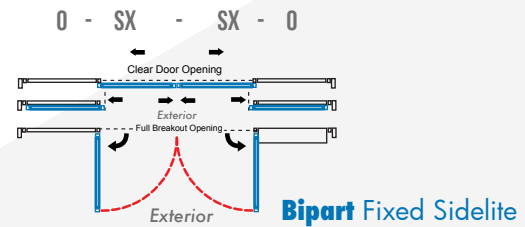
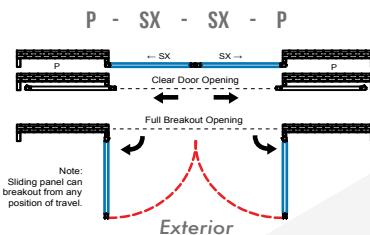
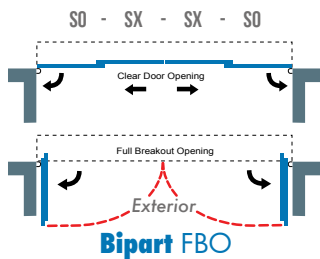

PORTALP USA, Inc

16170 Lee Rd, Suite 100
Fort Myers, FL 33912
Toll Free: 800-474-3667
Email: sales@portalp.com
www.portalp.com